



we  clean

# User Guide

Vax Careline: (UK) 0844 412 8455  
(ROI) 1-800 928 308

## Steam Cleaner

# steam home master



# Get Cleaning...

What's your Vax's model number?

e.g. S6

What's your serial number? (Located on the base of the machine)

Note these down in case you need them in future. Please keep instructions for further use.

# Machine Overview

- 1 Carry handle
- 2 Water tank lid
- 3 On/off button
- 4 Steam ready (green LED)
- 5 Water heating (red LED)
- 6 Variable steam dial
- 7 Hose inlet
- 8 Tool storage

## Unit

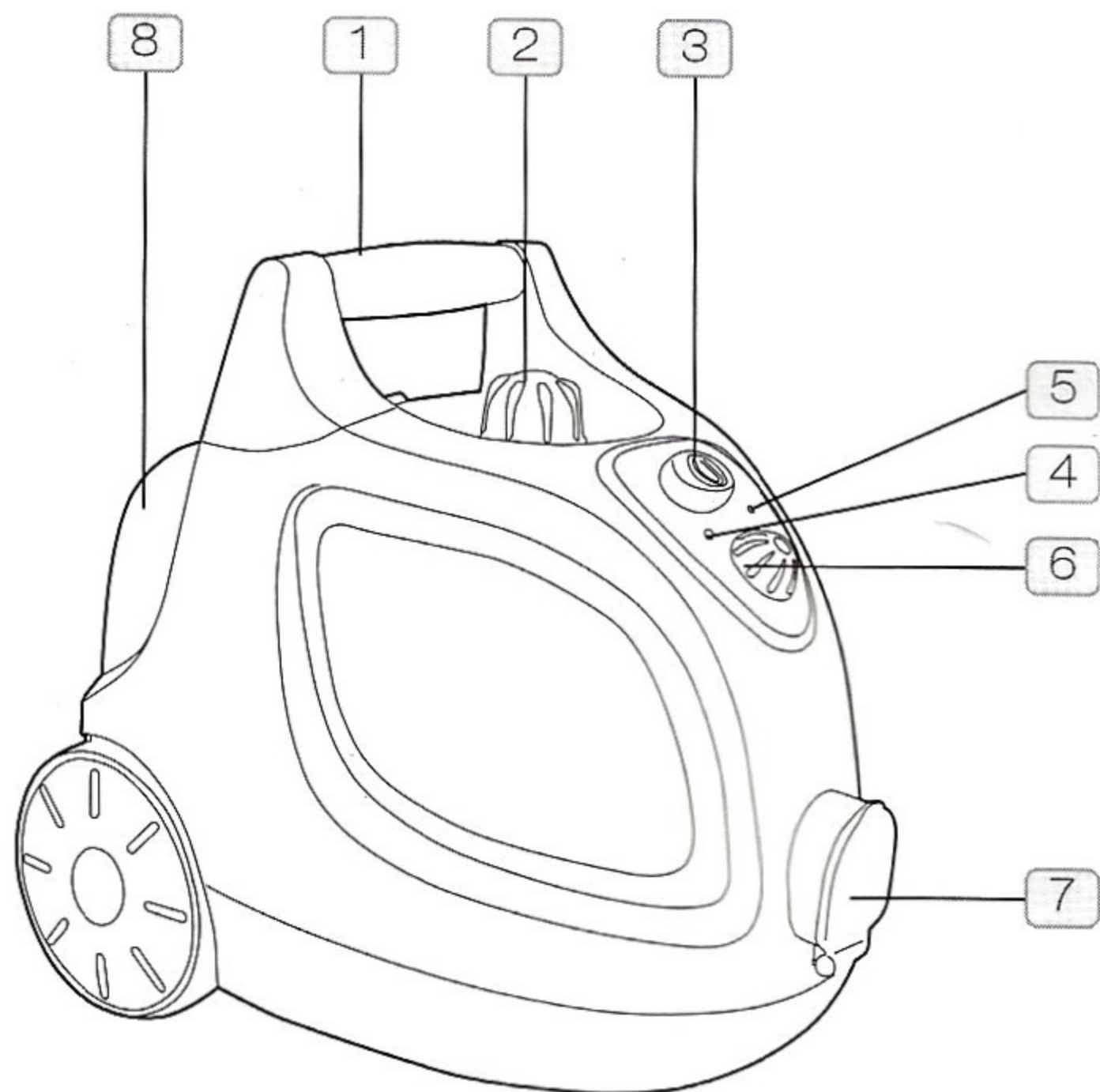

## Accessories

- 9 Steam handle and hose
  - a) Extension tube release
  - b) Safety latch
  - c) Steam trigger
- 10 Metal brush
- 11 Detail nozzle
- 12 Small plastic brush
- 13 Large plastic brush
- 14 Scraper tool
- 15 Concentration nozzle
- 16 Window/upholstery tool
- 17 Floor head
- 18 Floor head connector
- 19 Measuring jug
- 20 Funnel
- 21 3pc extension tubes
- 22 Upholstery cloth (x2)
- 23 Floor head cloth (x1)

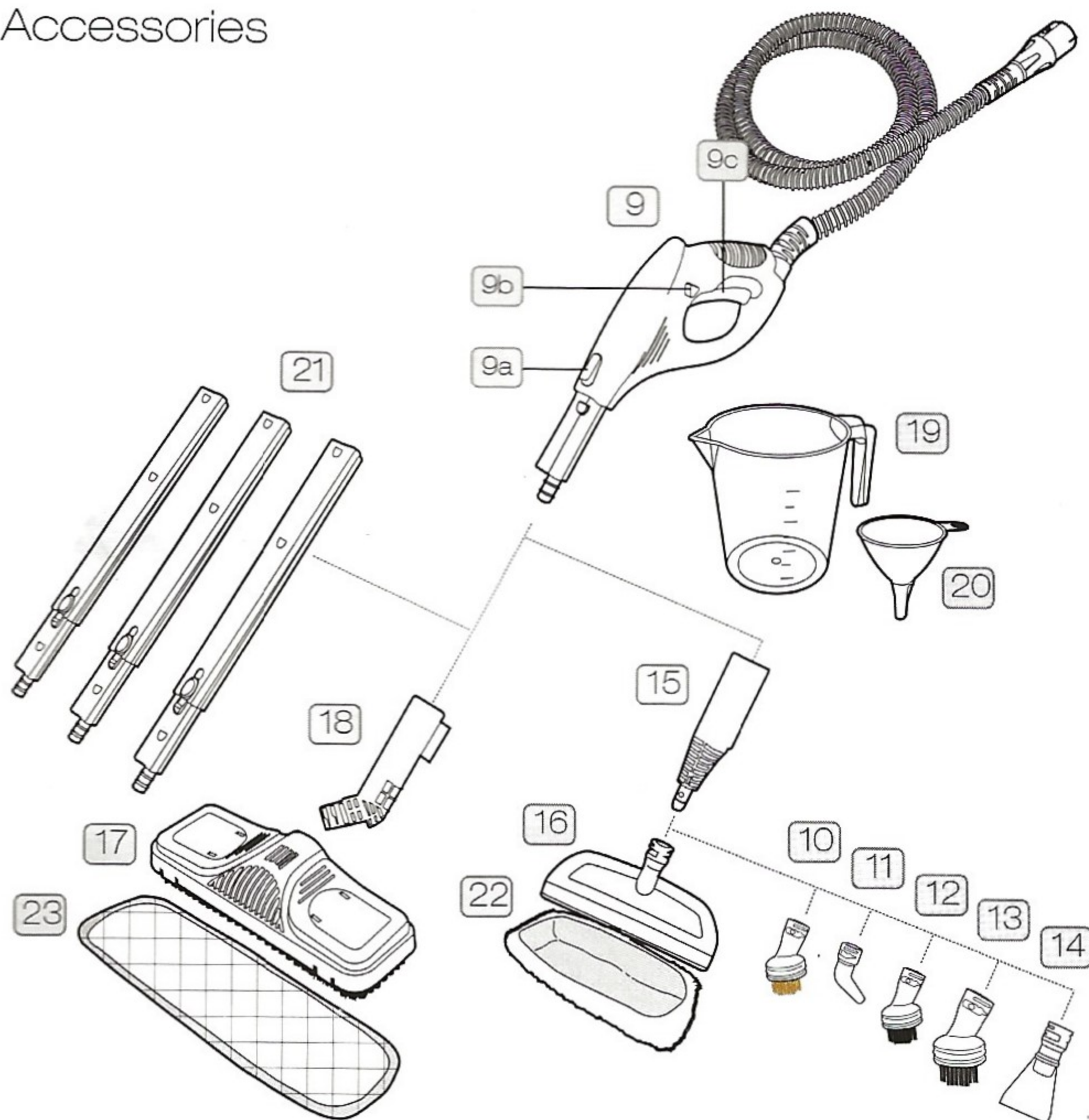

# General Safety Information

## FOR HOUSEHOLD USE ONLY.

When using the steam cleaner, basic safety precautions should always be observed, including the following:



**WARNING:** The steam cleaner unit and accessories get very hot during operation.



**DANGER OF SCALDING:** Avoid contact with the steam.

1. Do not leave the steam cleaner unattended when plugged in. Unplug it from socket when not in use.
2. To prevent electric shock do not use outdoors.
3. Not to be used as a toy. Close supervision is necessary when used near children or the infirm.
4. Use only as described in this manual.
5. Do not use the steam cleaner if it has been dropped, damaged, left outdoors or dropped into water. Do not use the steam cleaner with a damaged cord or plug. If the supply cord is damaged, it must be replaced by the manufacturer or a recommended Service Agent to avoid hazard and invalidating the guarantee.
6. Do not pull or carry by the cord, use the cord as a handle, allow the cord to come into contact with hot or sharp surfaces or close a door on the cord.
7. Do not unplug by pulling on the cord.
8. Do not handle the plug or steam cleaner with wet hands.
9. Do not put any objects into openings or operate with openings blocked.
10. Do not use without the tank cap in place.
11. Turn off all controls before unplugging.
12. Keep the steam cleaner on the floor.
13. Do not use an extension cord.
14. Do not attempt to remove blockages with sharp objects as they may cause damage.
15. Store indoors, put away after use to prevent tripping accidents.
16. Using improper voltage may result in damage to the steam cleaner and possible injury to the user. The correct voltage is listed on the rating label.
17. A hazard may occur if the steam cleaner runs over the power supply cord.
18. The steam cleaner must be kept level during operation.
19. Never immerse the steam cleaner in water or other liquids.
20. Keep the steam cleaner away from rain and moisture. The steam cleaner is not suitable for outdoor use.
21. Do not operate the steam cleaner without water in the tank. Always top up with water in good time.
22. Empty the water tank when the steamer is not in use.
23. Never fill the tank with anything other than water. Never put additives (such as perfume, stain remover or products containing alcohol) in the water as they may damage the steam cleaner or make it dangerous to use.
24. Always remove the mains plug from the socket and allow this steam cleaner to cool down completely before topping up with water.
25. Do not over fill the tank. Do not exceed the maximum prescribed filling level. Please use the measuring jug and funnel included.
26. Ensure that the water tank cap has been screwed down fully before use.
27. Only carry the steam cleaner by the carry handle.
28. Do not touch any hot areas on the steam cleaner. It is normal for the steam cleaner to heat up during operation.
29. Do not use the steam cleaner to treat any items of clothing that are still being worn on the body.
30. The force and heat of the steam may have an adverse effect on some materials. Always check whether a surface is suitable for treatment with the steam cleaner by carrying out a test beforehand on a concealed area.
31. Always include these operating instructions if passing the steam cleaner on to a third party.
32. Never aim the steam cleaner at people, animals or plants (risk of scalding)! Do not aim the steam cleaner at electrical systems or wires.
33. Please always switch the appliance off and remove the mains plug from the socket if leaving the work area.
34. The steam cleaner is fitted with a thermostat and a thermal cut-out as protection against overheating.
35. Accessories become hot during use - allow them to cool down before handling.
36. Please ensure all parts are correctly fitted before using the product.
39. Do not use your steam cleaner if damaged/faulty. Please call our Vax Careline on 0844 412 8455.



**NOTE:** The liquid or steam must not to be directed towards equipment containing electrical components, such as the interior of ovens.

**This steamer is for household use only and NOT for commercial or industrial use.**

**PLEASE KEEP INSTRUCTIONS FOR FURTHER USE.**

# Operation

## Operating your steam cleaner

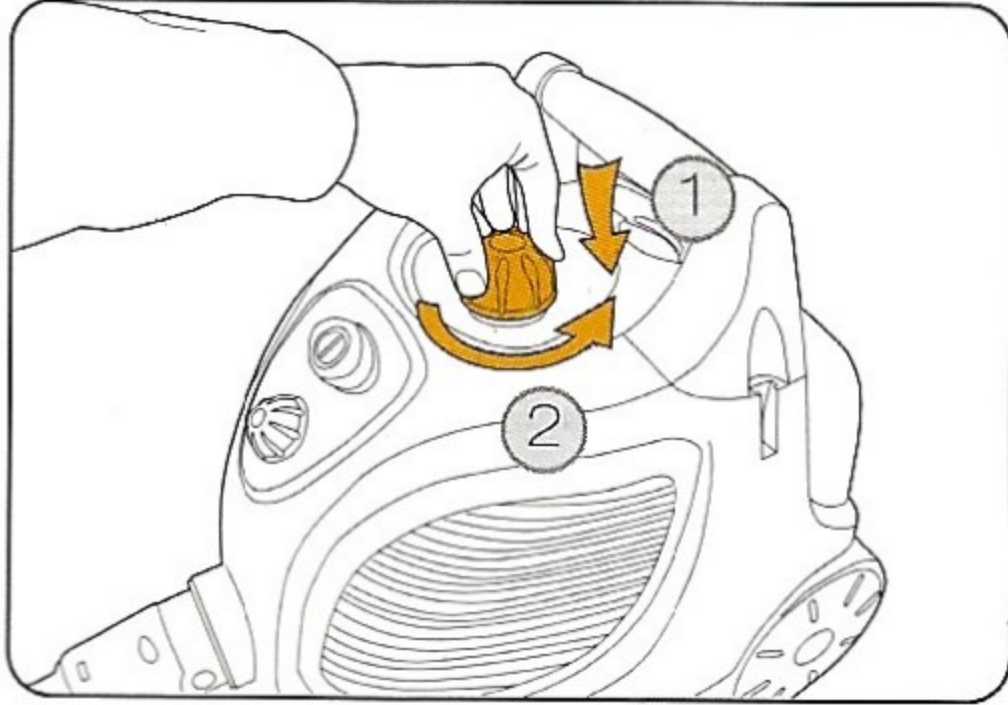

To remove lid push down and twist anti-clockwise.

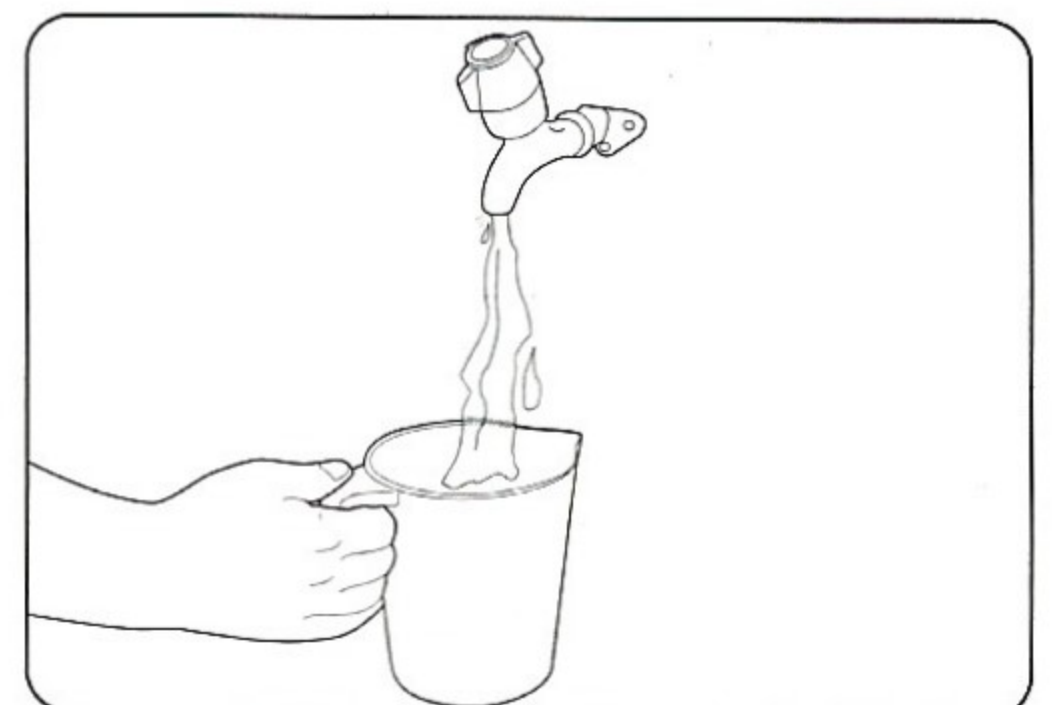
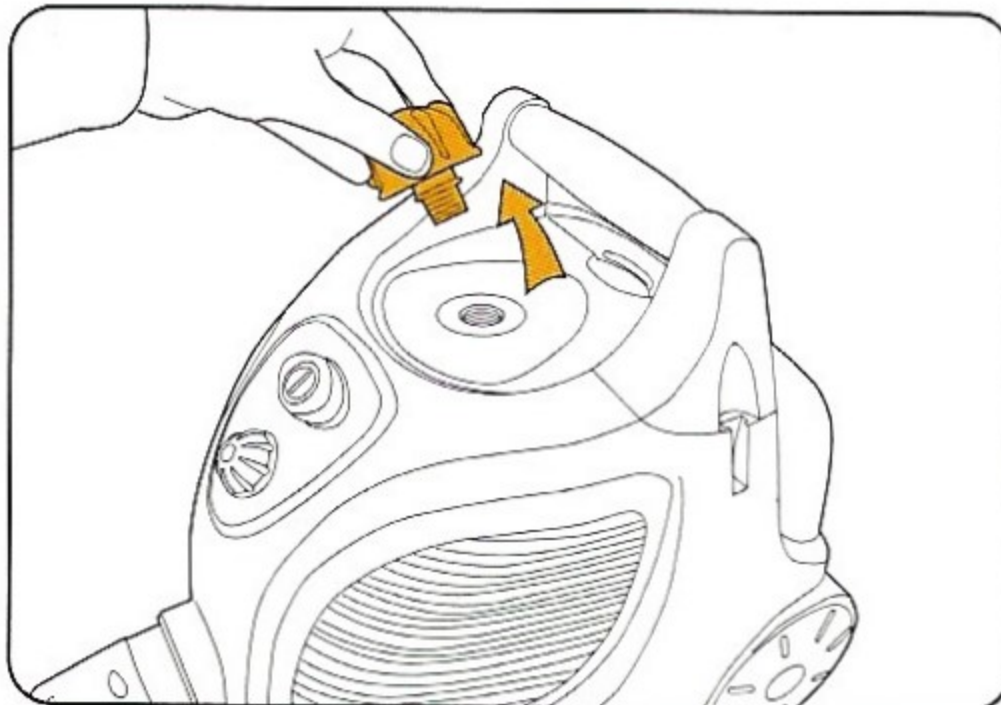

Fill measuring jug to max level as indicated.

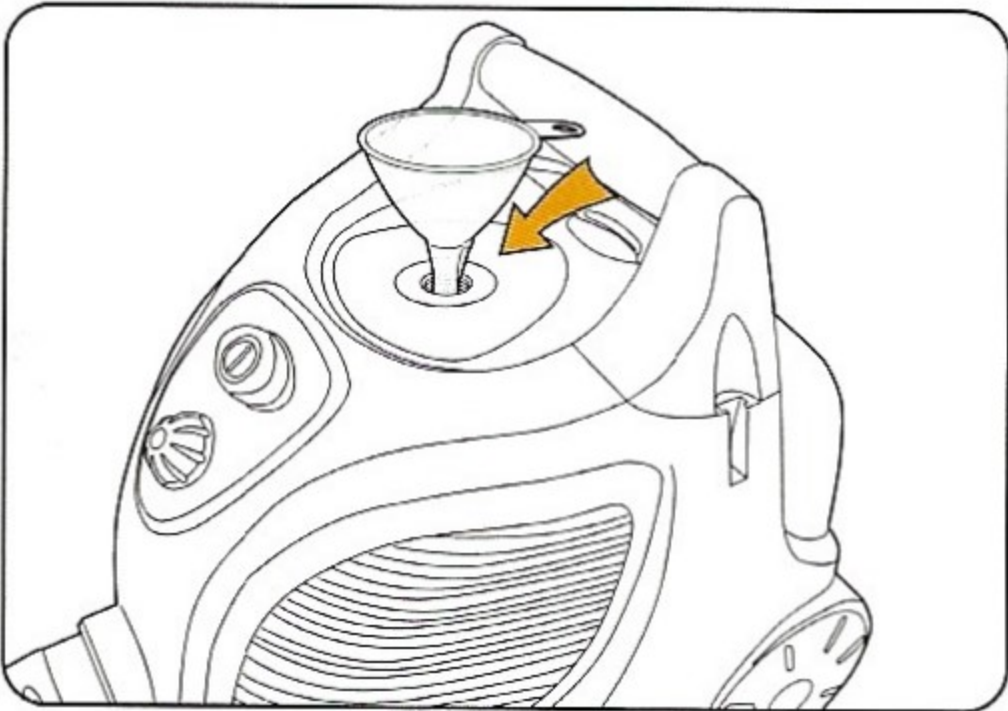

Insert the funnel into the water tank to make filling the tank easier.



Fill unit with water.

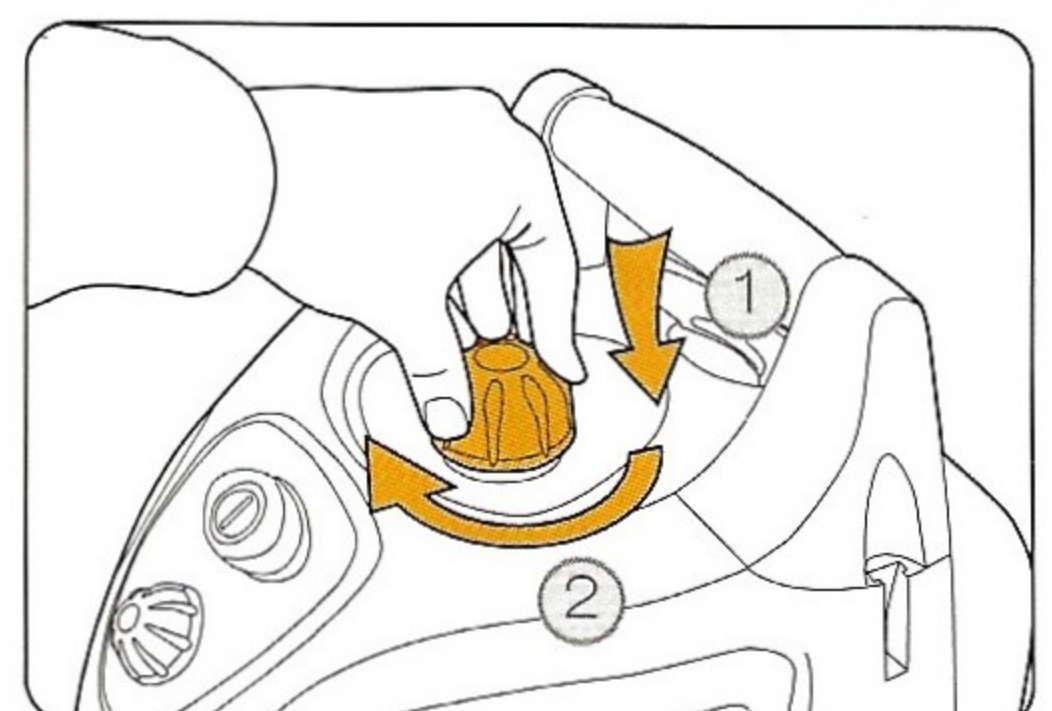

Ensure lid is securely fastened by pushing lid down and twisting clockwise.

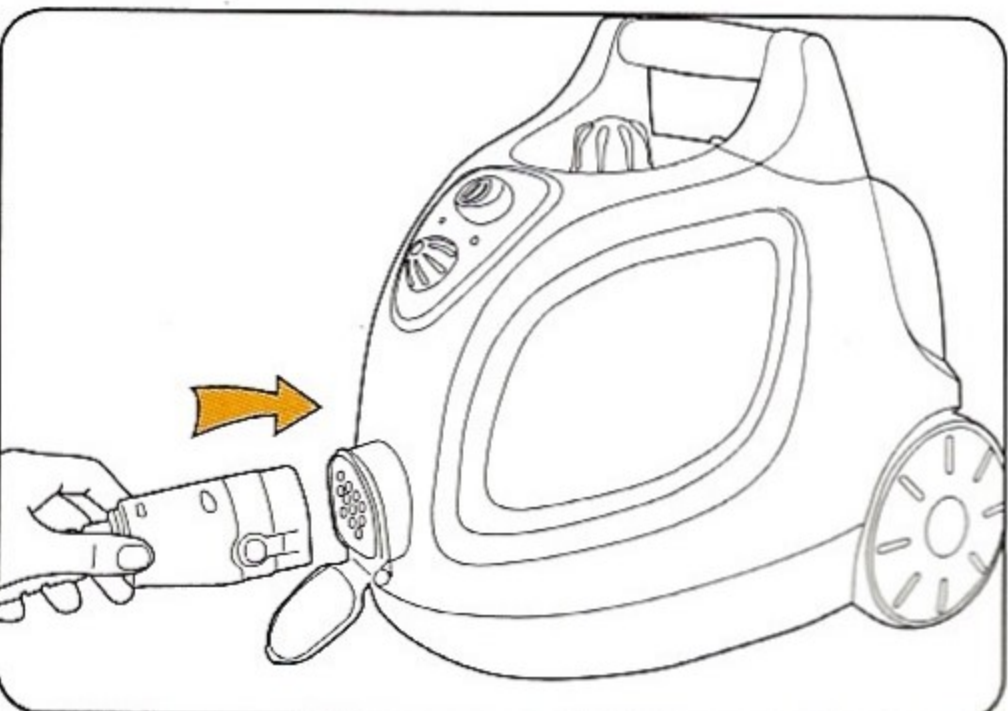

Attach hose to unit.

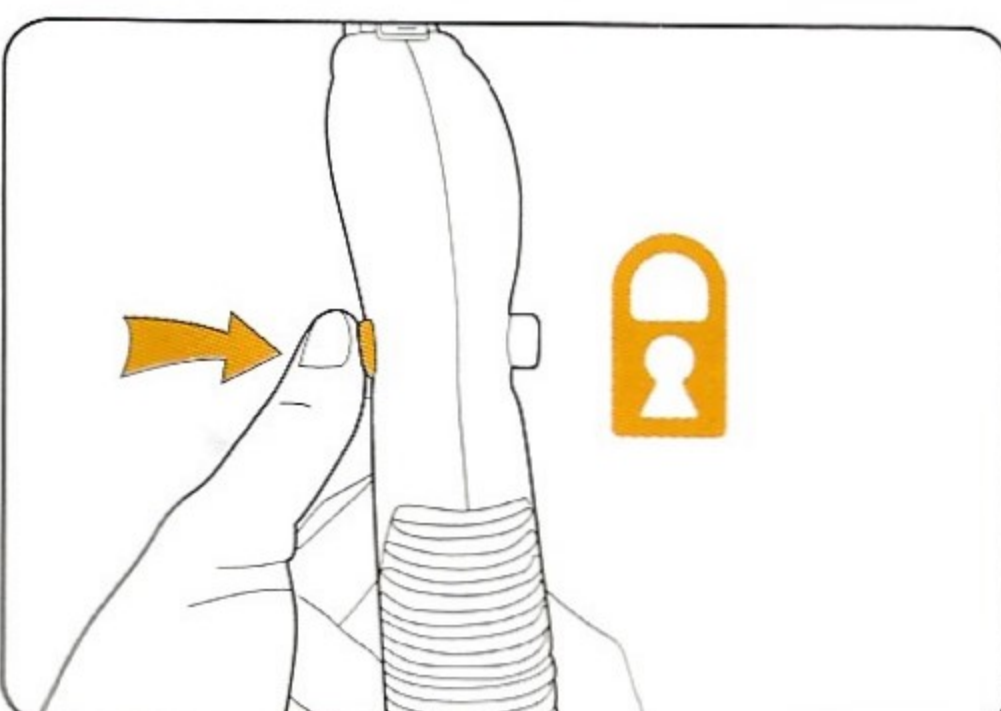

Ensure steam handle safety latch is on before heating.

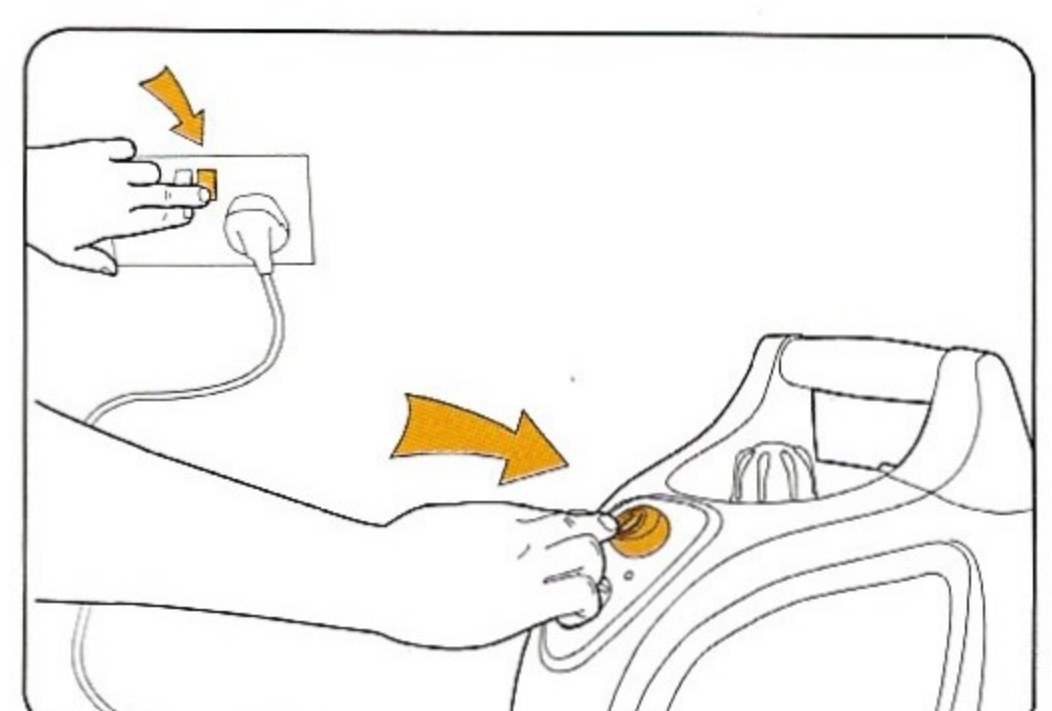

Turn steam cleaner on.

# Operation

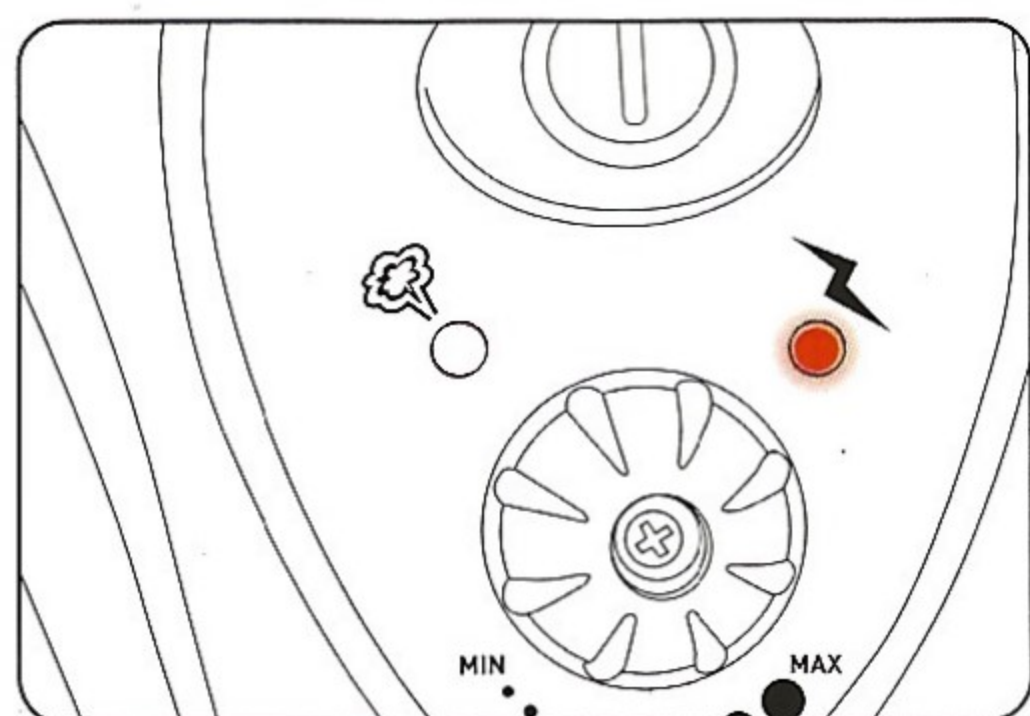

Red LED will illuminate when water is heating.

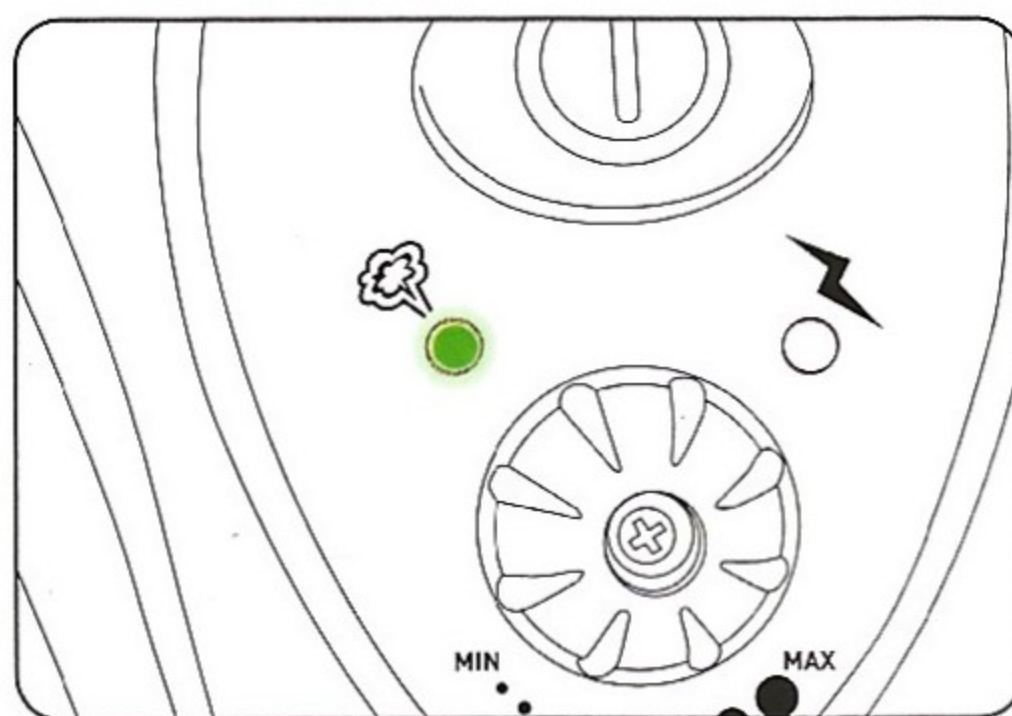

After approximately 12 minutes the Green LED will illuminate showing steamer is ready to use.

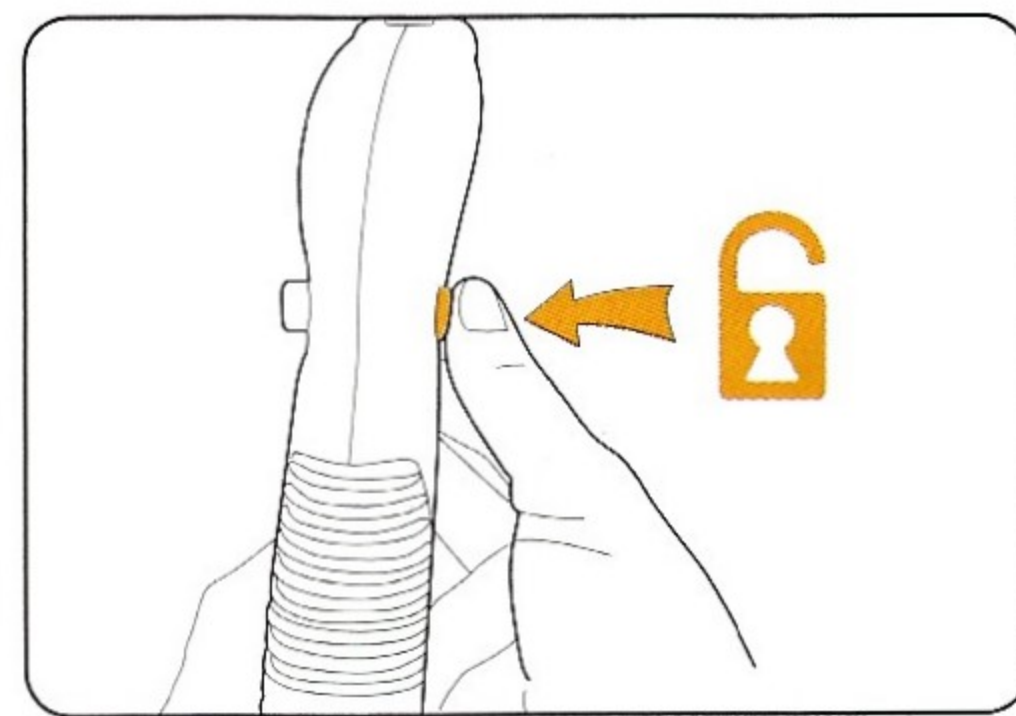

Release steam handle safety latch.

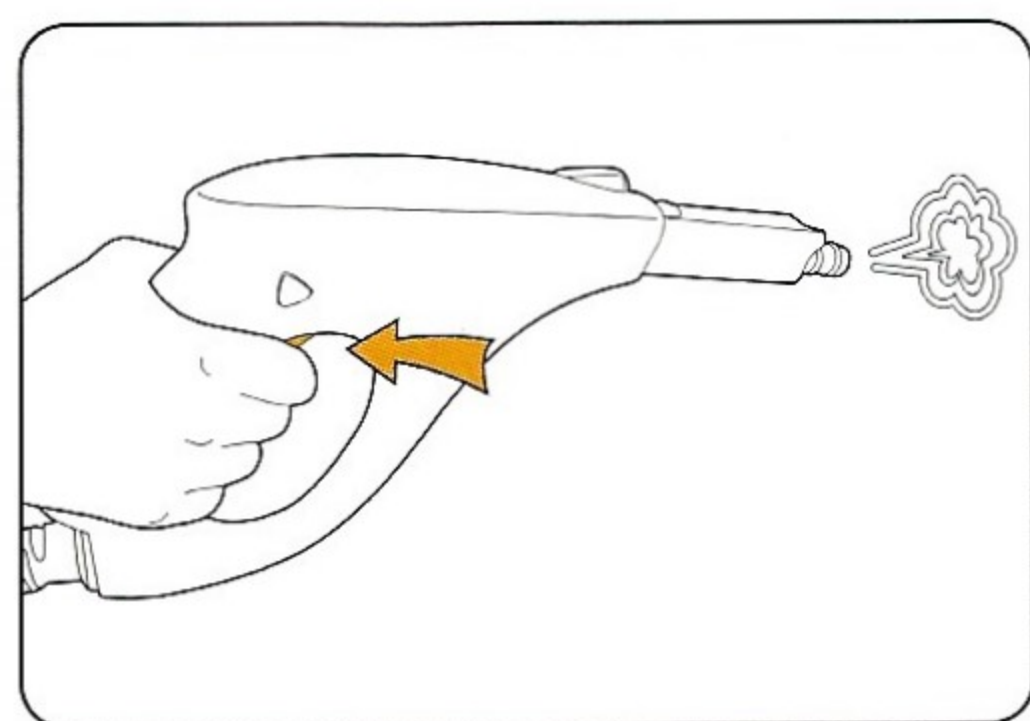

Press steam trigger to release steam.

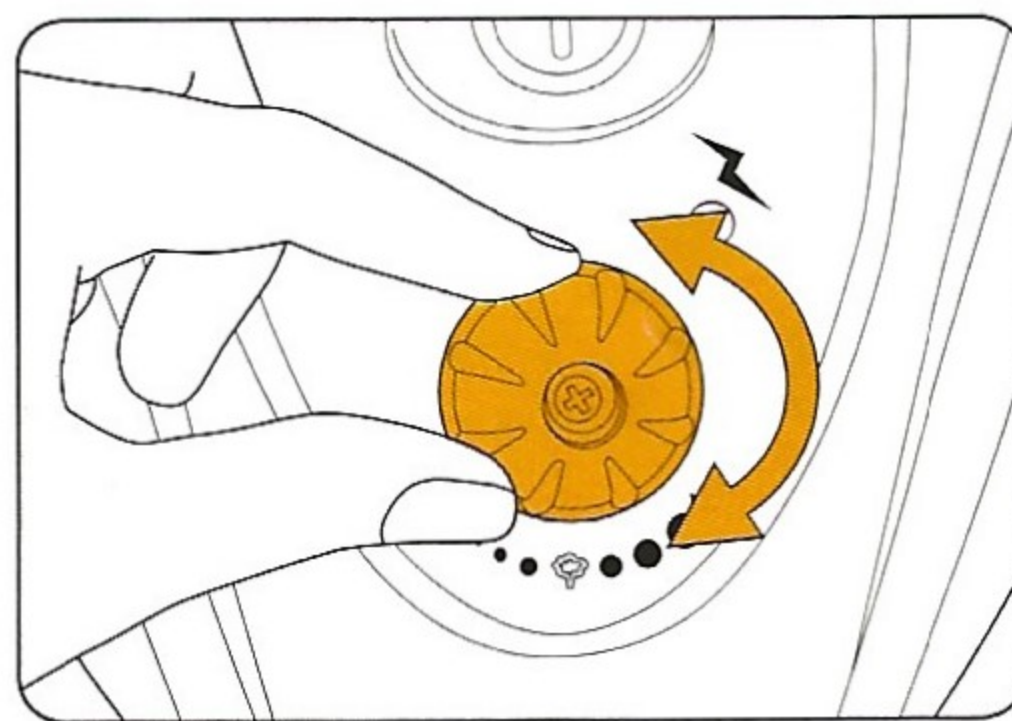

Rotate variable steam dial to adjust pressure.

# Operation

## Accessories

### Extension tubes

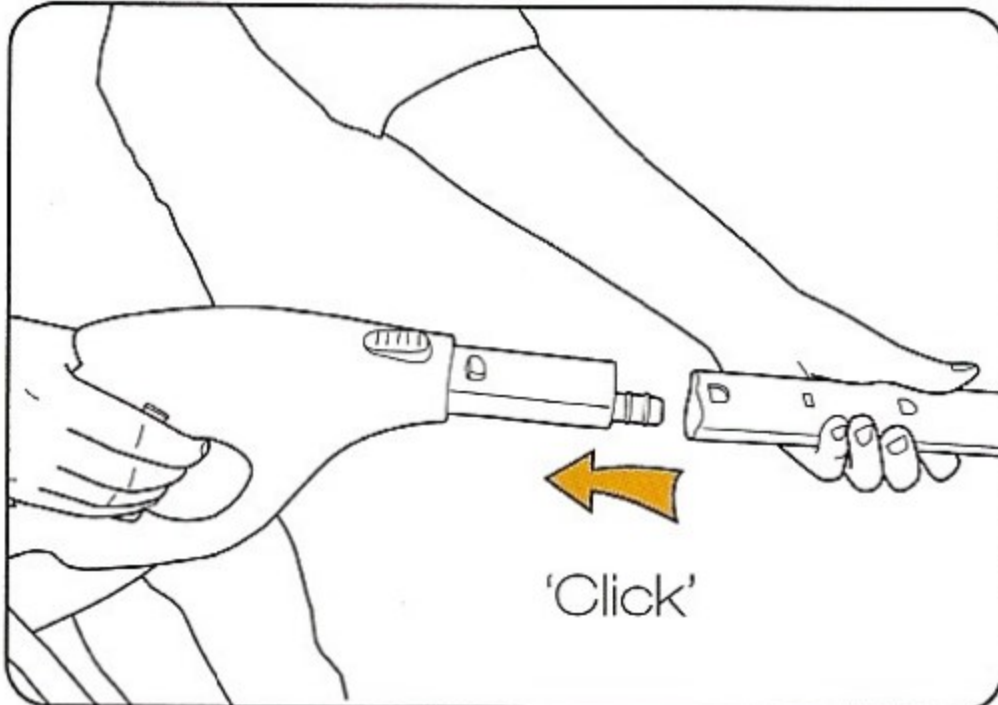

Attach extension tube to handle.

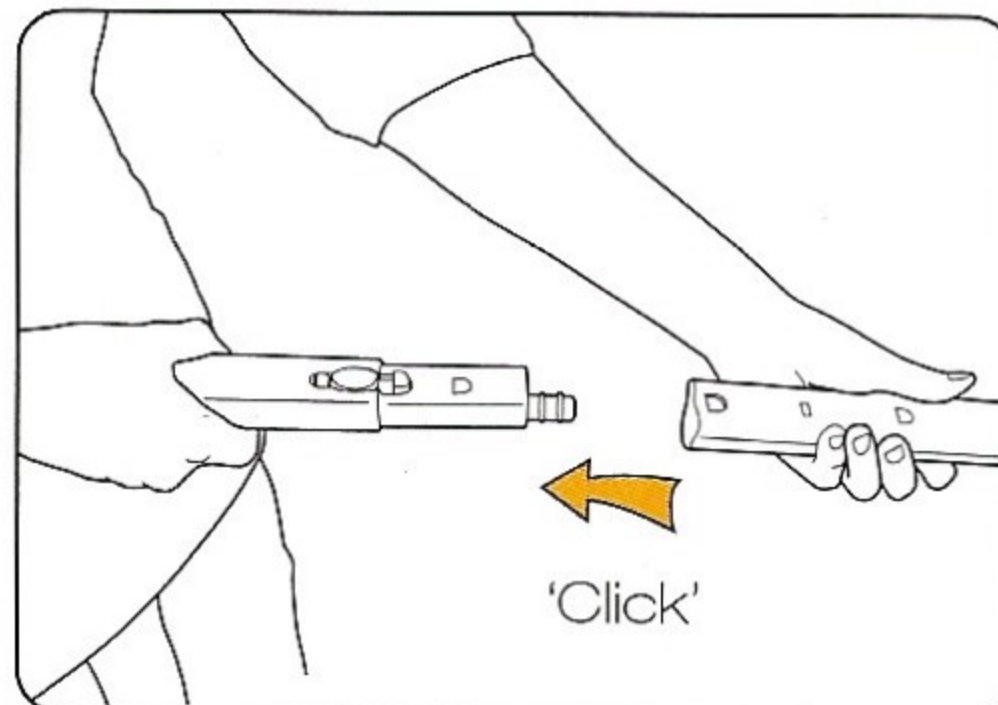

Attach extension tubes together.

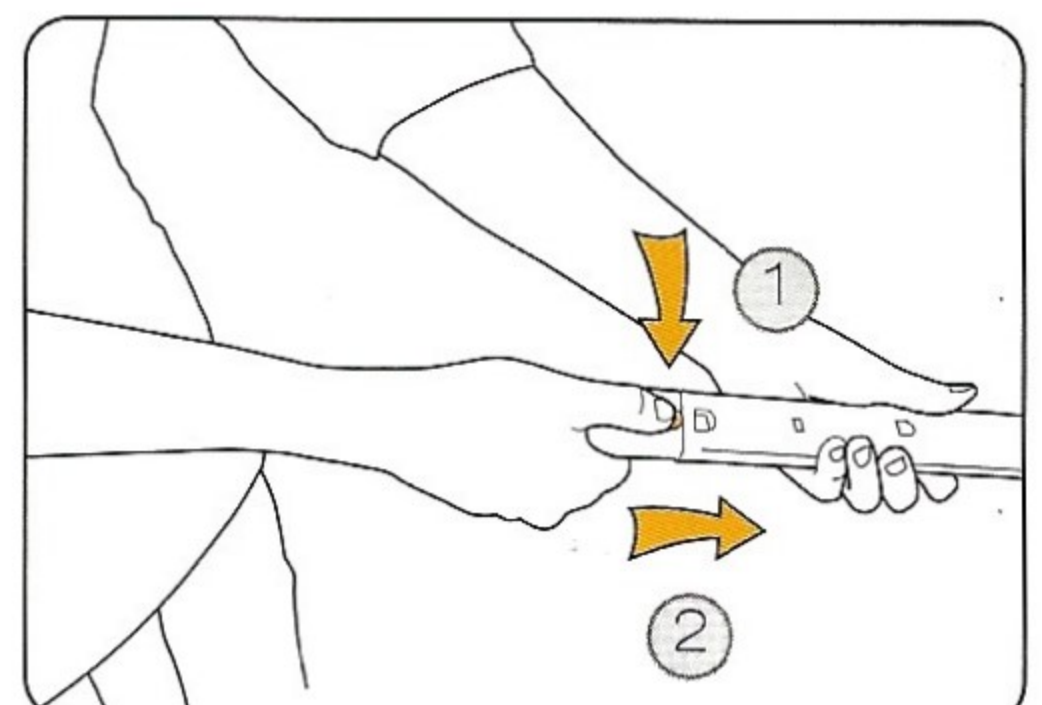

To remove/release tubes, press latch as shown.

### Floor head

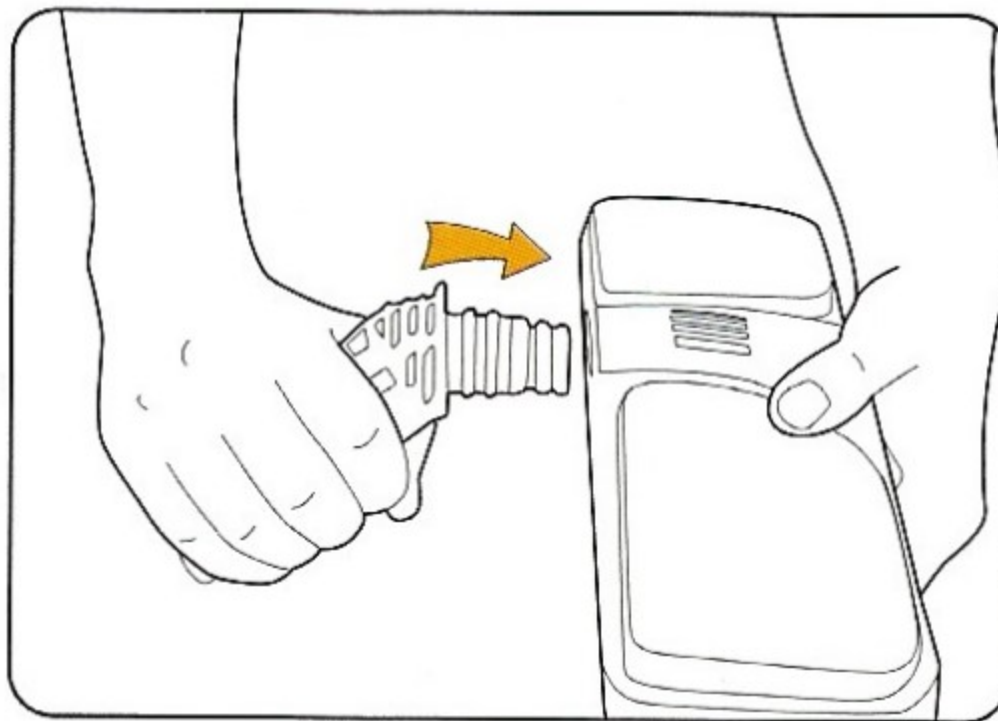

Attach the floor head connector to the floor head.

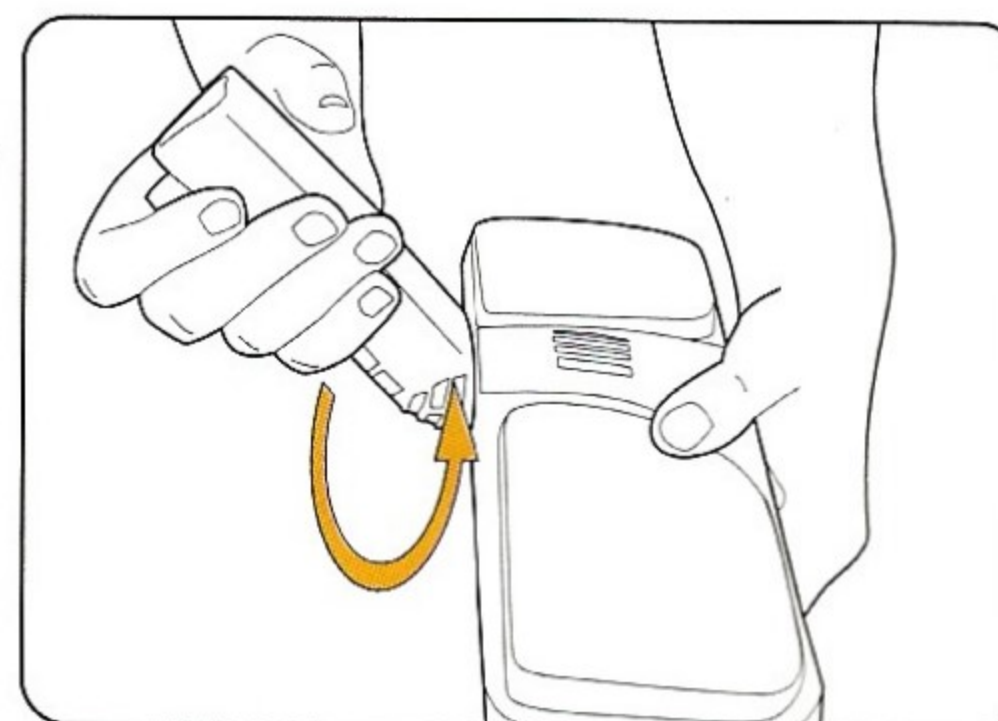

Rotate floor head connector into place.

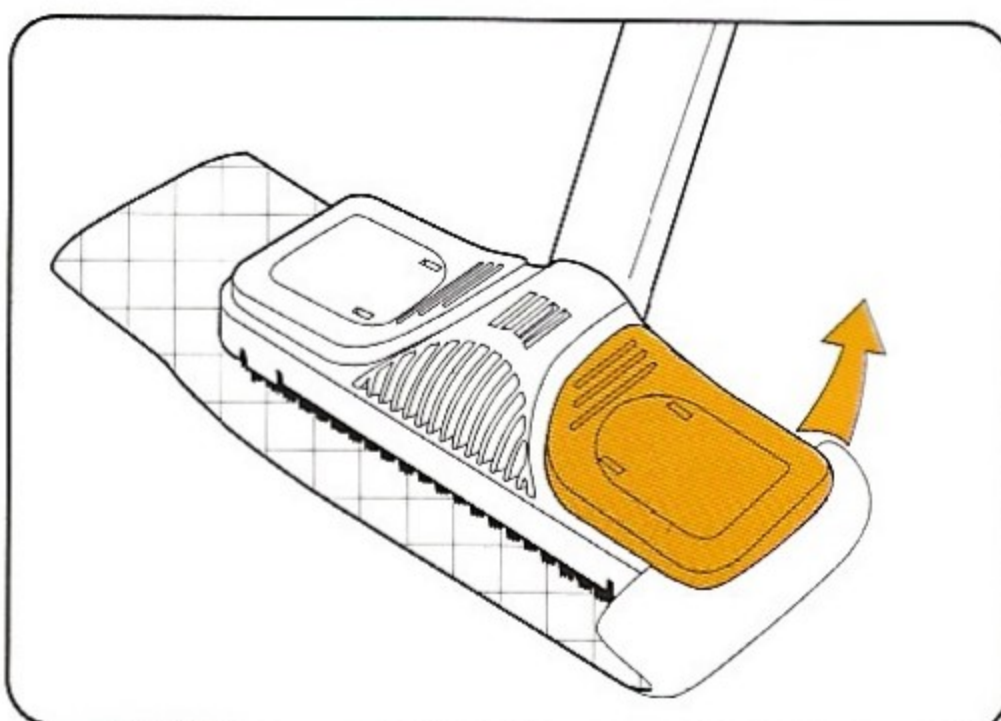
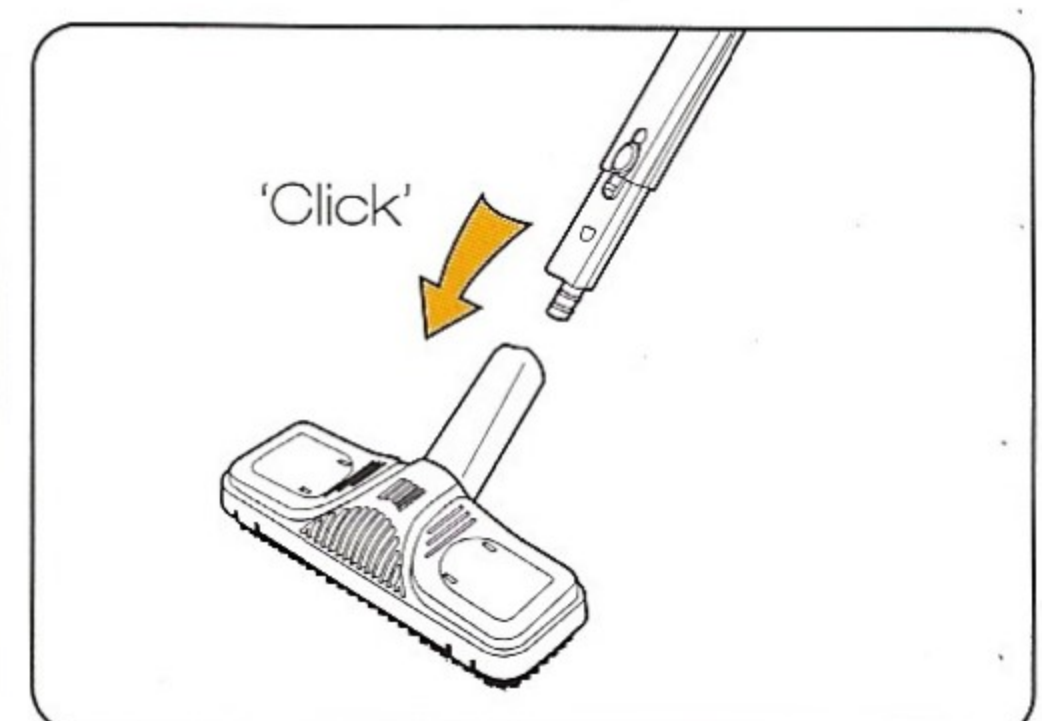

Lift levers on either side of the floor head to secure floor cloth.

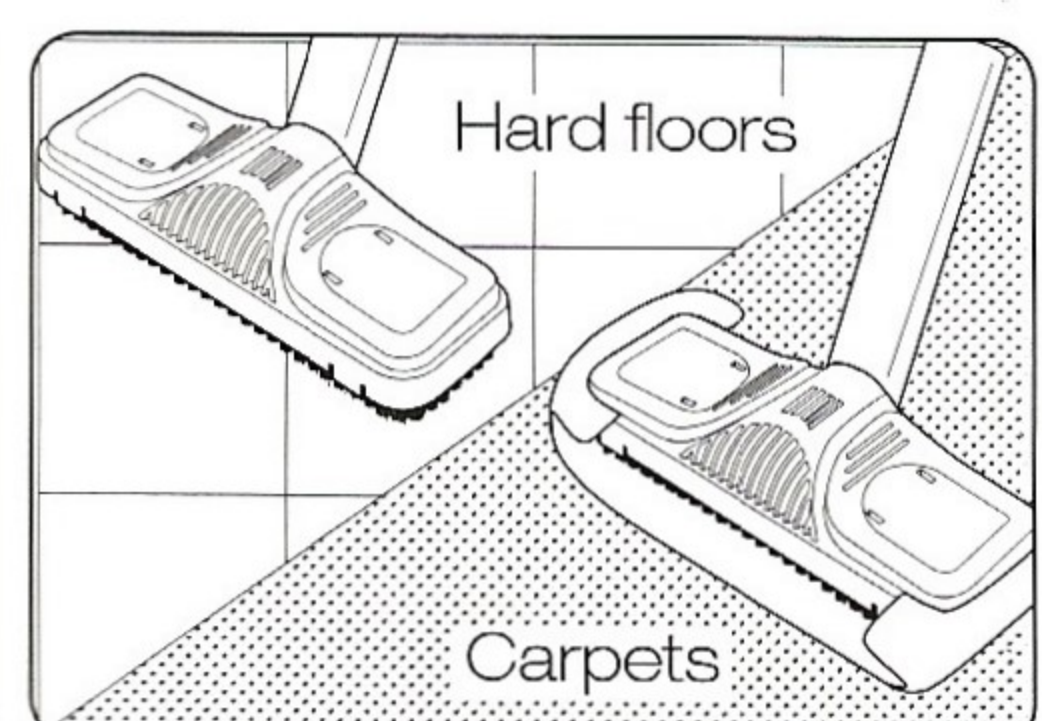

### Attaching small tools

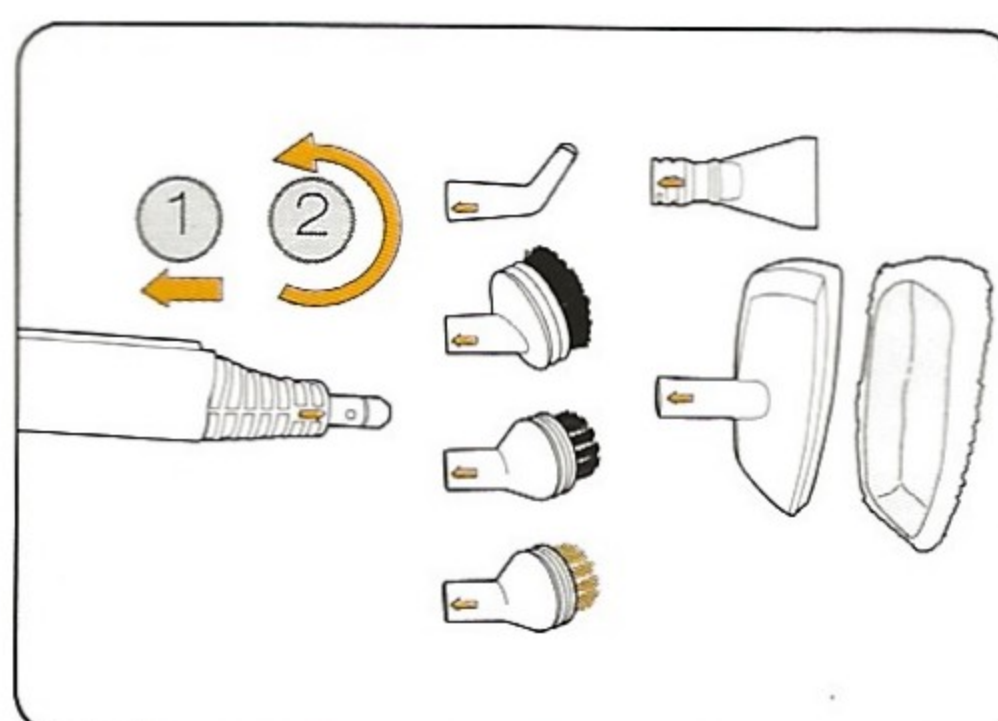
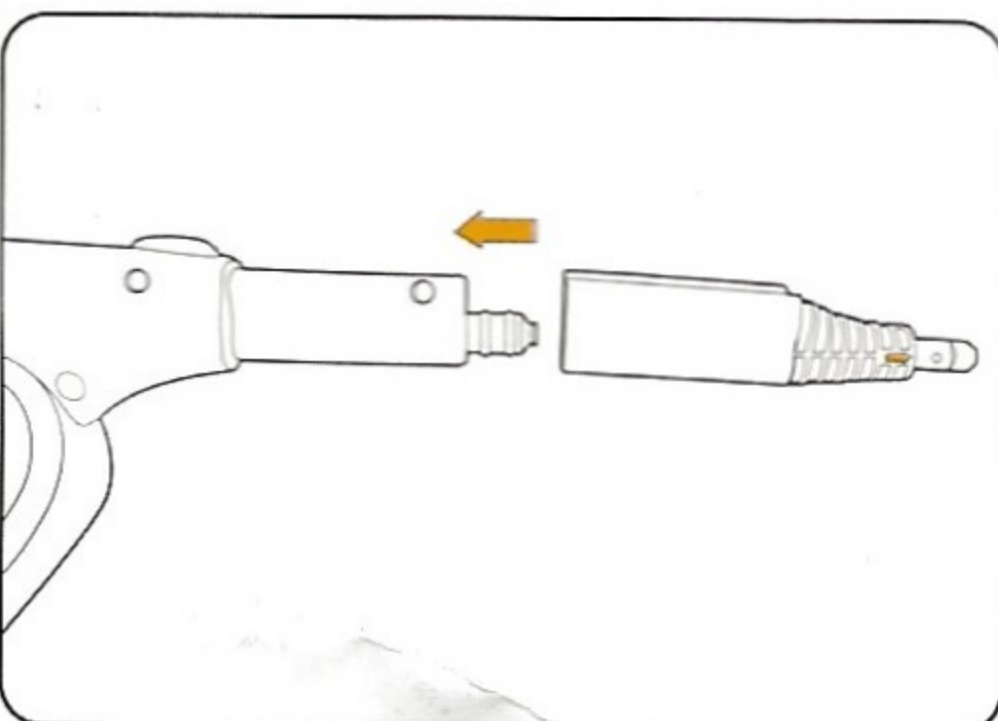

1 Push small tools onto concentration nozzle aligning arrows.

2 Twist clockwise to fit.

 **NOTE:** Concentration nozzle must be attached before fitting the small tools.

# Operation

## Accessories

### Using the small tools

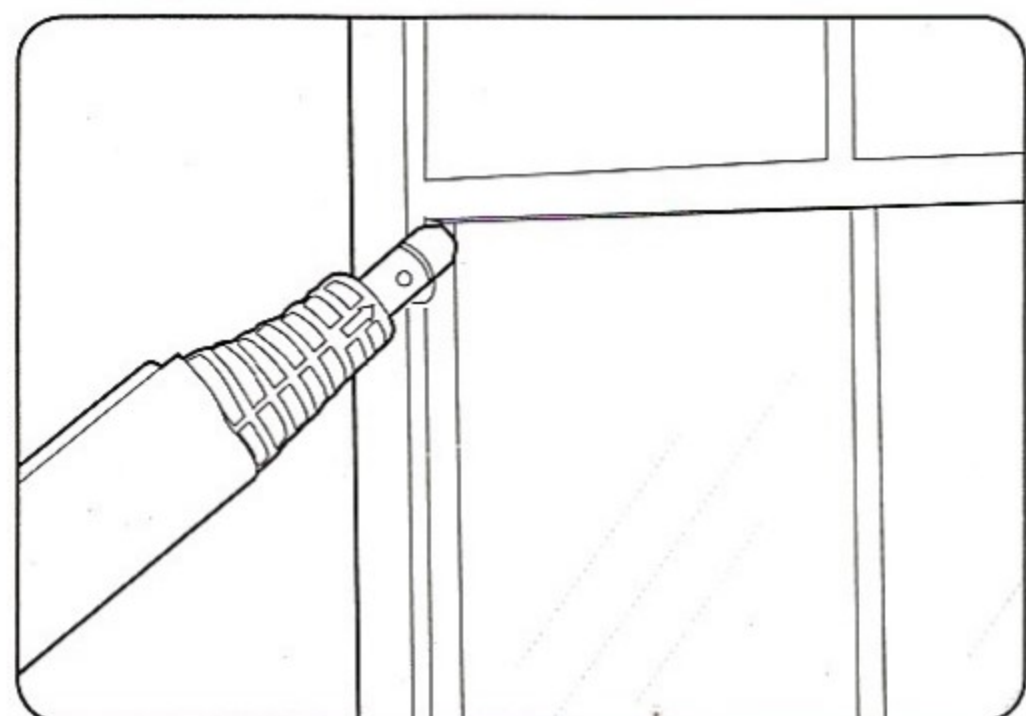

#### Concentration nozzle

Use to remove soap scum in baths and shower enclosures and to clean heavily soiled areas in kitchens.

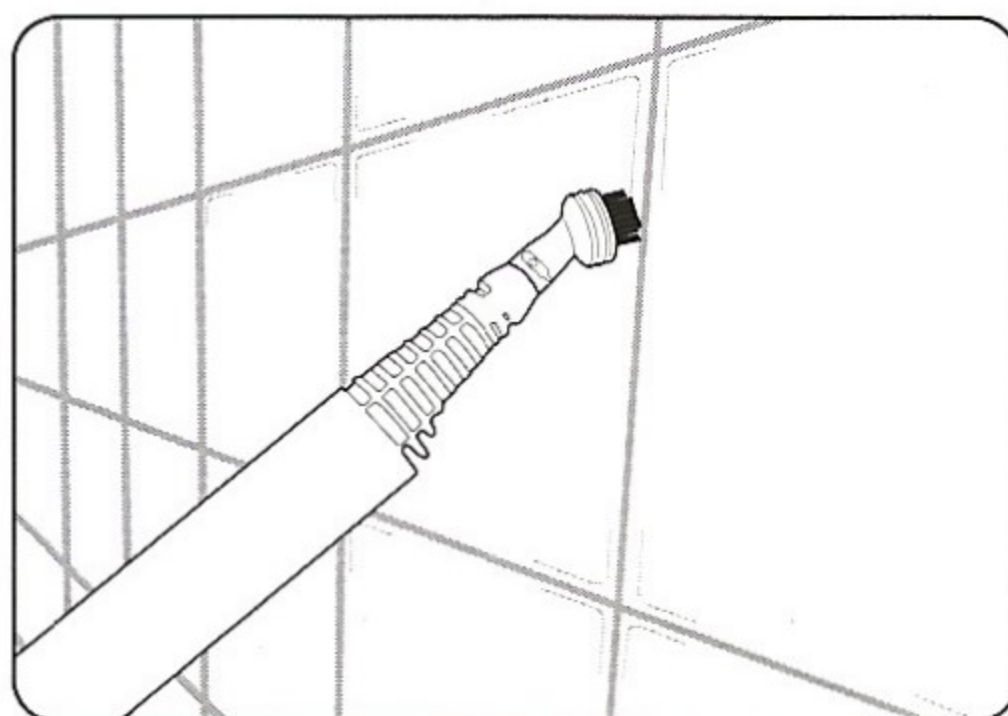

#### Brushes

Agitate stubborn grease and grime.

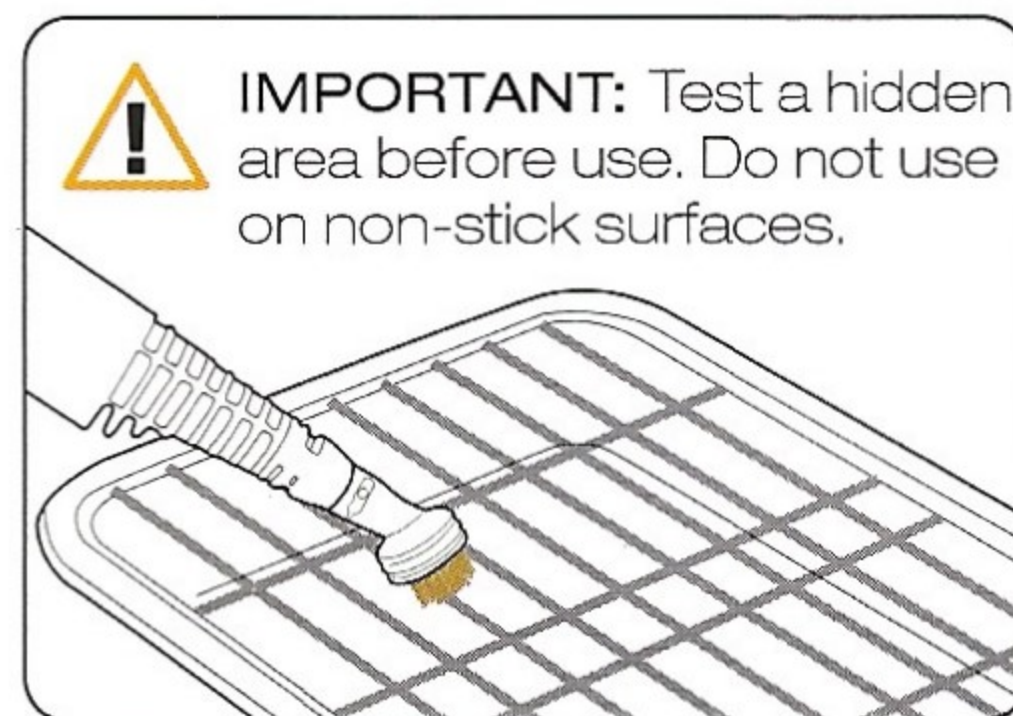

#### Metal brush

For oven grills and racks.



**IMPORTANT:** Test a hidden area before use. Do not use on non-stick surfaces.

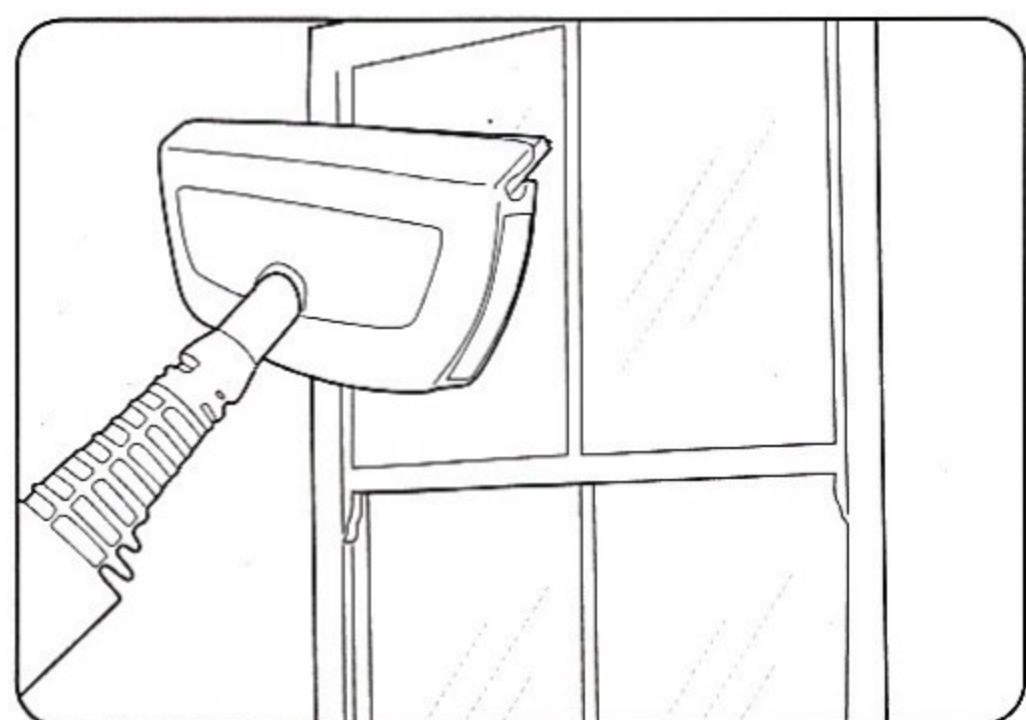

#### Window tool

Great for leaving your windows and mirrors gleaming and smear-free.

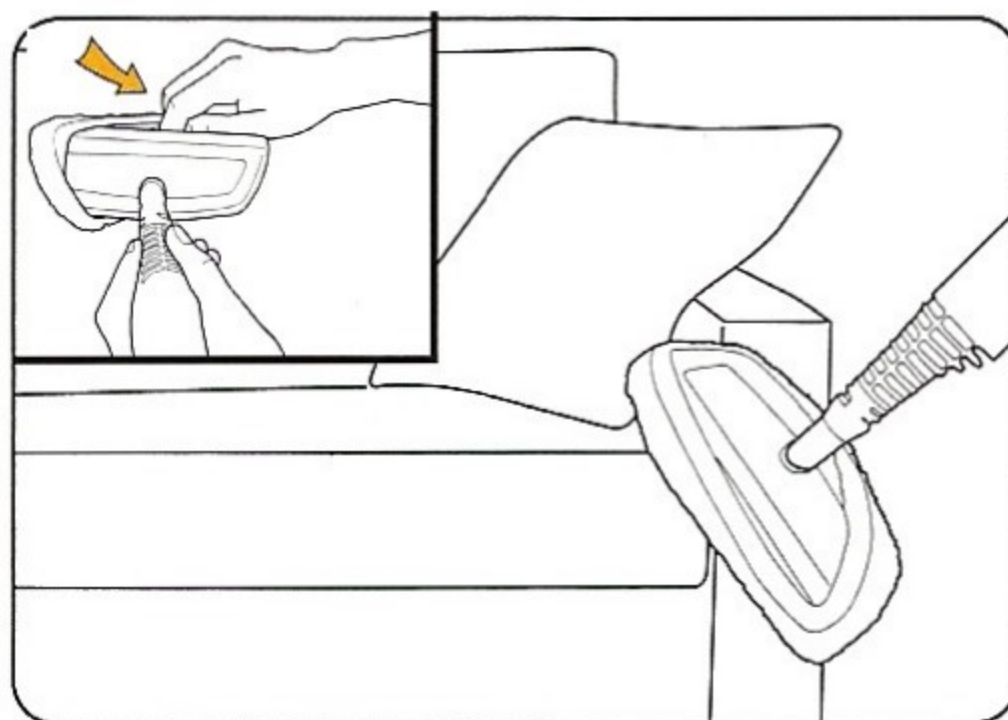

#### Upholstery tool

Attach the upholstery tool cloth to the window tool for use on sofa and chair fabrics.



**IMPORTANT:** Test for colour fastness in a small hidden area of upholstery to check for colour removal before use.

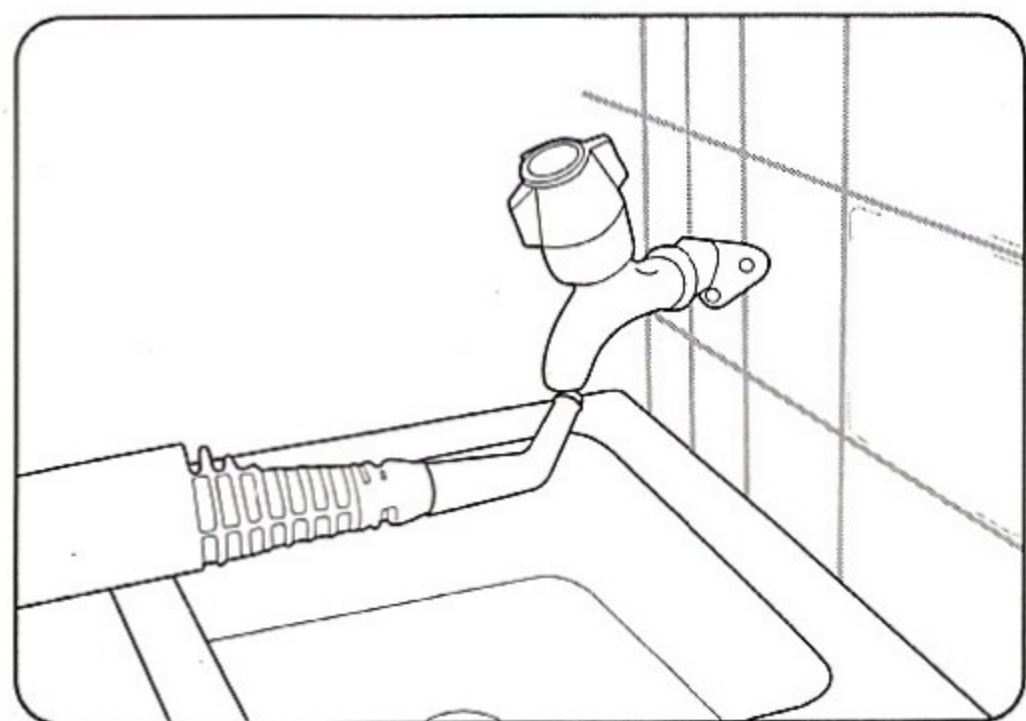

#### Detail tool

For hard to reach areas e.g. around taps.

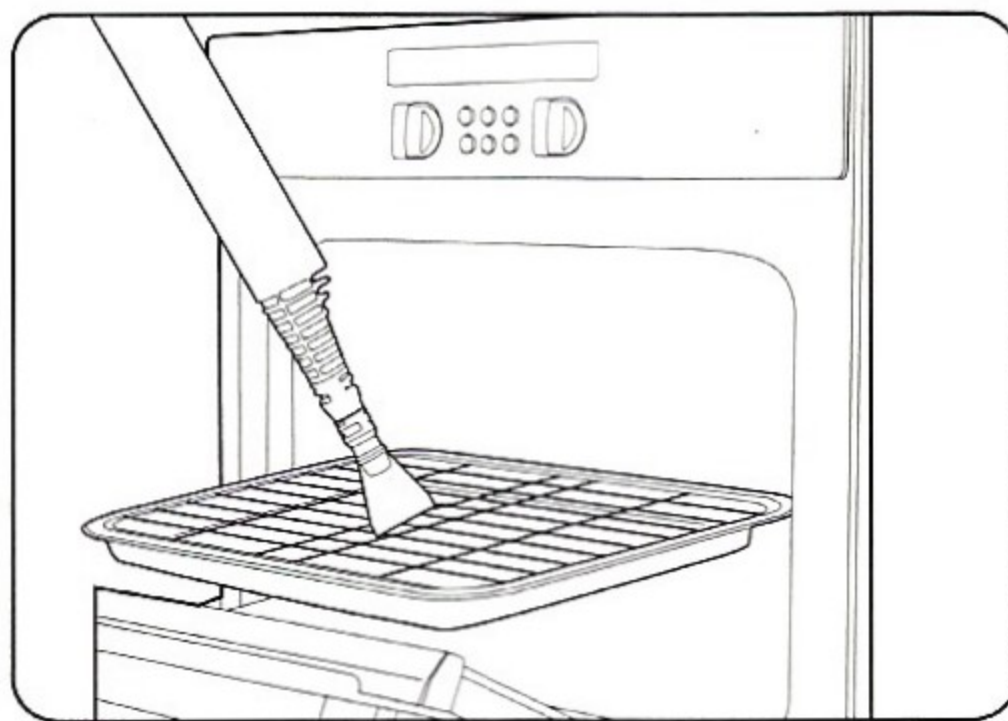

#### Scraper tool

Ideal for dried on residue in ovens. Can also be used to defrost freezers.

# Maintenance (Keep your Vax as good as new)

## Cleaning cloths

Cloths can either be washed by hand or machine washed at 30° C with mild detergent.

## Storage



**IMPORTANT:** Steam cleaner must have cooled down before storing.



**IMPORTANT:** When storing your machine, turn the unit off at the plug and hold steam trigger down to release remaining steam pressure.

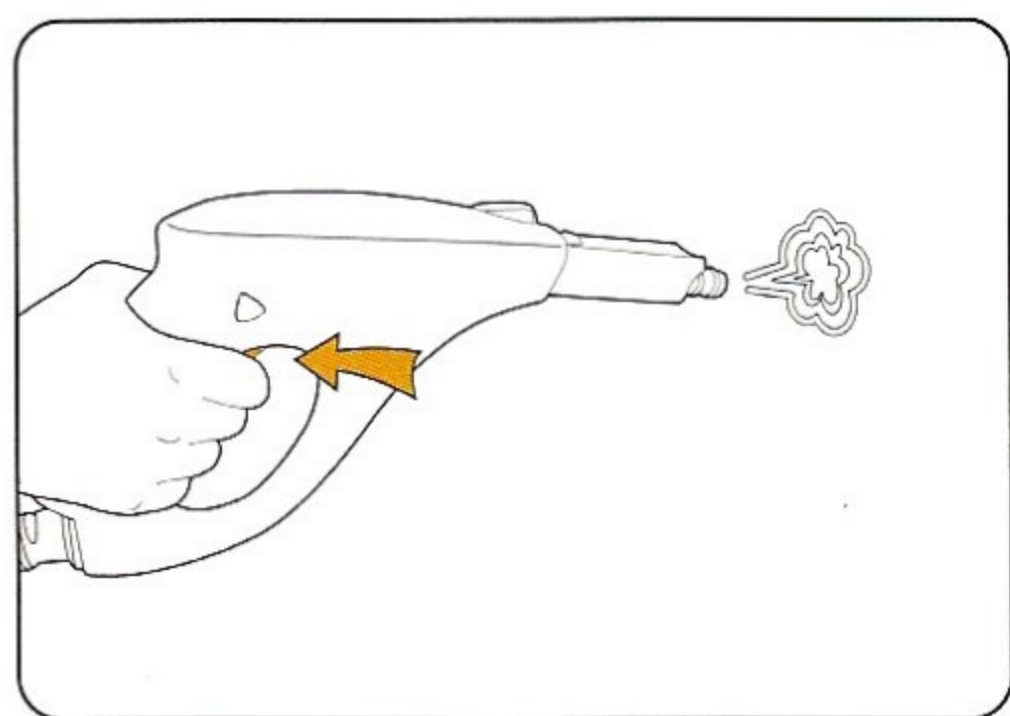

Press steam trigger to release steam.

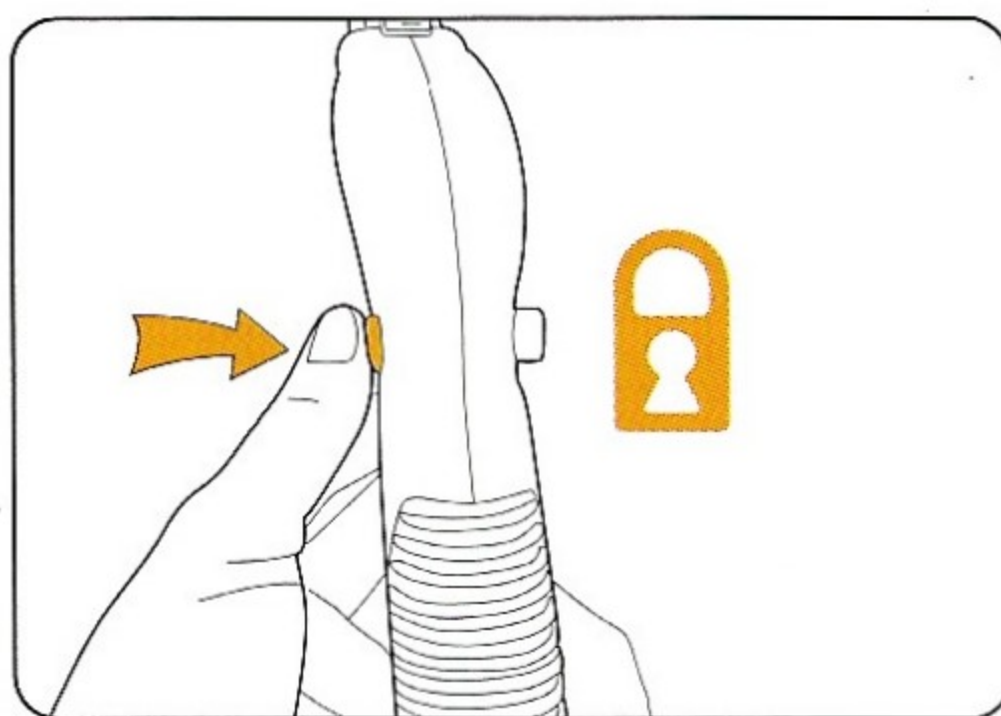

Ensure steam handle safety latch is on.



Empty unit of any remaining water.





**WARNING:** to reduce the risk of personal injury, unplug the steamer before performing maintenance/troubleshooting checks.

## Is there an accessory missing?

- Check the parts overview page in this guide to make sure the part is definitely included with your machine.
- If the part is missing, we're here to help. Simply call us on: **0844 412 8455**

## What do I do if the machine/an accessory has become damaged or broken?

- Visit [vax.co.uk](http://vax.co.uk) for spares and parts.
- Please call our Careline to purchase new spares or order a replacement.

## Why won't the steam cleaner run?

- The unit may not be plugged into an electrical outlet; ensure the plug is pushed in securely.
- Check the mains power is switched on.
- The electrical outlet may not be working; check the fuse or breaker and consult an electrician.
- The power cord may be damaged; if it is it must be replaced by the manufacturer.

## Why is the steam cleaner not producing steam?

- Ensure that the mains power is switched on and the power button has been pressed on the unit.
- There may be no water in the tank; please refer to the operation section.
- Check that the safety latch has been unlocked on the steam handle.
- The water may not yet be at temperature; the green steam ready indicator light will illuminate when the water is at temperature and is ready to use.
- If the unit is producing a very small amount of steam, check the variable steam dial and adjust to max.
- If none of the points above are of assistance, we're here to help. Simply call us on: **0844 412 8455**

## What do I do if the steam cleaner takes a long time to heat up?

- If you live in a hard water area the water tank may have become blocked by limescale - The unit will then need to be descaled.
- Otherwise, we're here to help. Simply call us on: **0844 412 8455**



we  to help

Don't take me back to the shop, simply call us

(UK) 0844 412 8455    [vax.co.uk](http://vax.co.uk)  
(ROI) 1-800 928 308    [vaxireland.ie](http://vaxireland.ie)

This does not affect your statutory rights

# Other Information

## Service & Help

Vax Careline:

(UK) 0844 412 8455

(ROI) 1-800 928 308

Monday-Friday 8.30am to 6.30pm

Saturday-Sunday 9.00am to 5.00pm

If you have any queries about using your Vax, call the Vax Careline. Please make a note of the serial number and model number of your product before calling. For the nearest Service Agent, please call the Vax Customer Careline or visit [vax.co.uk](http://vax.co.uk)

## Technical Specification

|                      |                    |
|----------------------|--------------------|
| Voltage:             | 220 – 240 v ~ 50Hz |
| Wattage:             | 1600W              |
| Water tank capacity: | 1.6L               |
| Cord length:         | 6m                 |
| Weight:              | 4.7kg              |

Subject to technical change without notice.



## EEC Statement of Compliance

Manufacturer/EEC importer: Vax Limited, hereby on our own responsibility, declare that the S6 steam cleaner series is manufactured in compliance with the following Directives:

**Safety:** 2006/95/EC Low Voltage Directive

**EMC:** 2004/108/EC Electromagnetic Compatibility Directive



Waste electrical products should not be disposed of with household waste. Please recycle where facilities exist. Check with your Local Authority or retailer for recycling advice.

# Notes



we  clean

Vax Ltd., Kingswood Road, Hampton Lovett, Droitwich, Worcestershire, WR9 OQH, UK  
email: [info@vax.co.uk](mailto:info@vax.co.uk) - website: [vax.co.uk](http://vax.co.uk)